

2700 SERIES



Audio Test and Measurement System

Unmatched Performance



Audio Precision's 2700 series is the newest generation of the company's award-winning PC-controlled audio test and measurement instruments, long the recognized worldwide standard for the design and test of audio equipment. The 2700 series continues to provide the unmatched distortion and noise performance required to test the latest advances in converter technology, while raising the bar with new 192k digital input and output capabilities.

In the SYS-2722, a true dual-domain architecture provides uncompromised performance for both analog and digital signals: the hardware generator and analyzer specifications surpass those of any digital configuration, while digital analysis techniques offer a wide array of high-speed, precise measurements for either domain. Cross-domain work can be accomplished using the best of both worlds.

The 2700 series

- The unparalleled precision of a dedicated hardware instrument.
- Fast instrument operation and powerful analysis under sophisticated control software.
- Programmatic control for high-speed automation.
- Serial digital interface testing.
- Flexible configuration options.
- * A family of auxiliary instruments for specialized testing.
- * AES3, IEC60958 (SPDIF) and PSIA input and output sample rates at 192 kHz.

The 2700 series. Proven, reliable, high-performance technology from Audio Precision, the industry's preeminent audio test and measurement company.

Unparalleled Precision

Low Distortion

Analog system 1 kHz THD+N, 20 kHz BW ≤ -112 dB
(Typical worst case harmonic < -130 dB)

Digital generator distortion/spurious products ≤ -160 dB

High Bandwidth

Analog signal generation to **204 kHz**

Analog measurements to **500 kHz**

Analysis by FFTs and Multitone to **120 kHz**

Low Noise

Analog analyzer 22 Hz–22 kHz BW ≤ -118 dBu

Analog analyzer A-weighted ≤ -124 dBu

Flat Response

Analog system 20 Hz–20 kHz
typically ± 0.003 dB

Low Crosstalk

Analog inputs 20 Hz–20 kHz ≤ -140 dB

Analog output 20 Hz–20 kHz ≤ -120 dB

Low Jitter

700 Hz–100 kHz BW ≤ 600 ps

50 Hz–100 kHz BW ≤ 1.0 ns

FFT Acquisitions

Up to **4 M Samples** (87 s @ 48 kHz F_s)

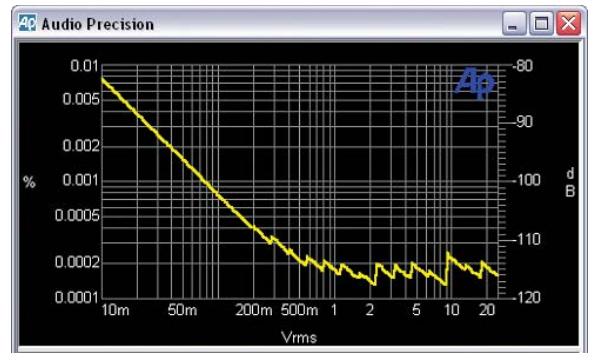

Analog system 1 kHz THD+N, 20 kHz BW ≤ -112 dB



2700 series dual-domain model SYS-2722 192k

The 2700 series control software is a powerful and sophisticated real-time interface that runs on a PC controlling the instrument. Hardware and software system modules and functions are operated by settings on software panels, with measurements provided in panel reading displays. Settings and readings can be swept and plotted on X-Y graphs, modified by various algorithms, compared against limits or analyzed by DSP techniques. The control software is flexible and configurable, addressing a wide range of uses from benchtop engineering to production testing.

Test setups, measurement data, graphs and other test components are saved on the PC. These files can be emailed or exchanged between co-workers to quickly duplicate test setups, study test results or publish reports — regardless of location.

The 2700 series control software supports Microsoft Windows® 98, Windows 2000 and Windows XP. Graphs and data can be pasted into other Windows-compatible applications and can be exported in a number of different formats.

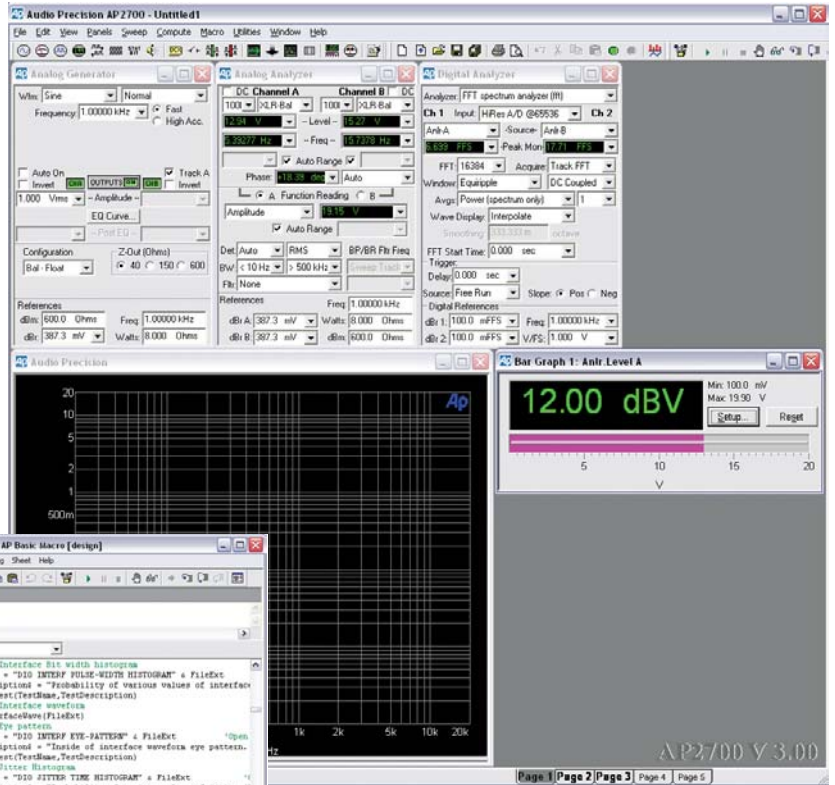

Create and edit macros and verify your code using the Step and Trace mode in the Macro Editor.

- GPIB versions of each 2700 series model are available, providing an IEEE-488 interface for compatibility with third-party automated testing instruments.

- The entire testing process can be automated for repeatability and speed by programmatically controlling the 2700 series instrument using AP Basic, the Audio Precision programming language included with the 2700 series. Every setting, reading and setup parameter in the 2700 series control software is available in the AP Basic command set. AP Basic supports complex, branched testing programs as well as simple step-by-step macros.

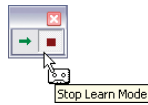

- You can create, edit and run AP Basic macros without ever leaving the control software. The Macro Editor provides complete editing, debugging and syntax help.

- AP Basic works with the control software using ActiveX Automation. The entire command structure is accessible to Microsoft Visual Basic®, enabling you to integrate your 2700 series instrument with a wide variety of applications and equipment.
- Learn Mode is a “macro recorder” that provides a fast and convenient way to generate automated test macros, even if you have little programming experience.
- A Dialog Editor provides an easy way to design a custom user interface “front-end” for your automation macros. Drag-and-drop in the Dialog Editor, and the underlying code is written into the Macro Editor script.

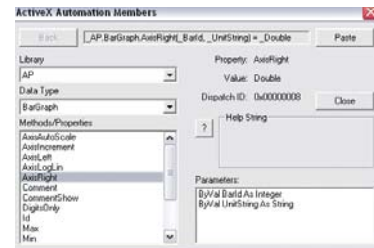

Use the Object Browser to easily integrate commands and correct syntax while working in the Macro Editor.

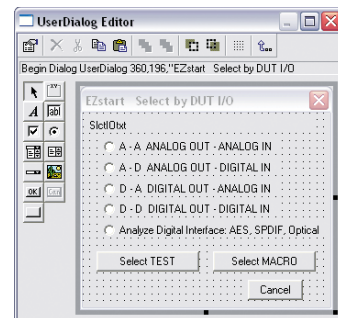

Design professional user interface panels within your macro using the Dialog Editor.

Unparalleled Speed

The 2700 series offers an array of powerful, time-saving analysis tools to speed your testing procedures.

Multitone Multitone testing techniques can provide response, distortion, noise, crosstalk and phase measurements — all from a single sub-second acquisition. You can address a wide variety of high-speed testing applications by choosing a standard stimulus waveform, or by making your own using the multitone creation utility. In addition to great speed, multitone analysis brings other advantages: a stimulus signal, for example, that is a rich mix of frequencies, levels and phase relationships that more closely resembles program material than conventional single stimulus tones; and the unique ability to measure noise or very low distortion products in the presence of signal.

Fast detection The DSP-implemented Fast RMS Detector speeds sine wave sweeps by making measurements in as little as one cycle of the sine wave. This can provide an improvement in testing speed of an order of magnitude compared to normal RMS detector techniques.

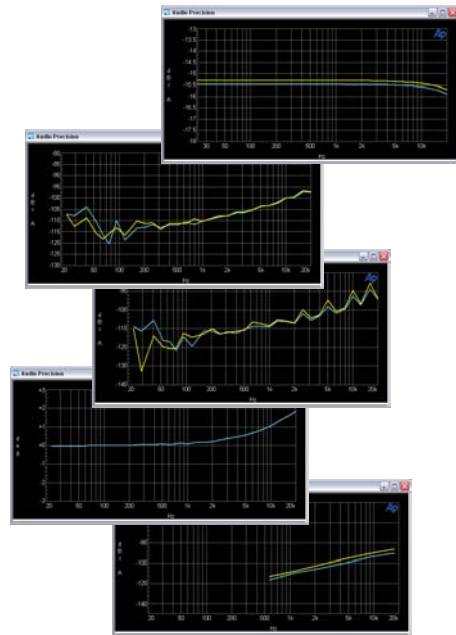
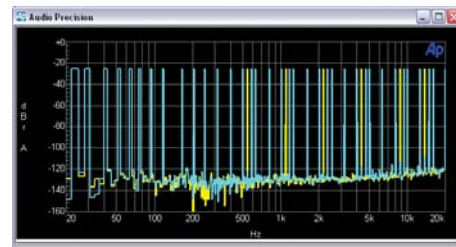

The graph at the top shows a spectrum display of a multitone stimulus. The next graphs are examples of five dual-channel parameters plotted against frequency, all produced from a single multitone stimulus lasting less than one second.



Harmonic selection controls and a graph of individual harmonic amplitudes plotted against frequency.

Proprietary Harmonic Distortion Analyzer An FFT-implemented dual-channel Harmonic Distortion Analyzer can simultaneously measure the individual amplitudes of a fundamental frequency and up to four harmonic products, selectable from the 2nd to the 15th harmonic. Sweeps using this analysis tool can rapidly characterize frequency or amplitude dependent distortion mechanisms.

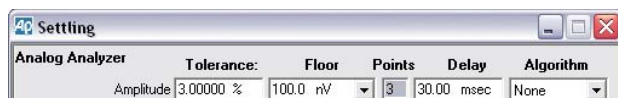

Fast data settling A sophisticated data settling algorithm enables you to optimize the inherent trade-off between testing speed and measurement accuracy in sweep tests. Individual settling parameters are stored for every measurement available in the instrument.

MLS analysis Quasi-anechoic measurements of transducers and acoustic spaces can be performed using MLS (Maximum Length Sequence) signals and analysis to produce impulse, frequency and phase response graphs in less than one second.

Hardware and software filters Make noise measurements to virtually any international standard using our extensive collection of weighting and band-limiting filters. Use optional Audio Precision hardware filters (for the Analog Analyzer) or Audio Precision software filters (for the DSP Audio Analyzer); or make your own user-downloadable software filters using the Filter Creation Utility.



Loudspeaker impulse response graph, showing a 6.6 ms delay before the impulse peak.

Digital Interface Capabilities

The 2700 series offers both AES3 and IEC60958 serial digital interfaces, with fully configurable serial data and clock ports available via the auxiliary PSIA-2722 Programmable Serial Interface Adapter.

All digital input and output capabilities are functional over the full range of sample rates from 8 kHz to beyond 200 kHz.

The Digital Input/Output panel provides complete control and display of serial interface parameters including connector and format selection, sample rate, resolution, pulse amplitude, active data bits, error flags and received jitter amplitude. A Status Bits panel enables you to set and read interface metadata in both professional and consumer formats. Metadata is displayed in both hex and English interpretations.

Test the performance of AES3 or 60958 receivers with sub-standard signals by introducing impairments to the output serial interface signal. Impairments include variable sample rate, pulse amplitude and rise and fall times, the addition of noise, common-mode signals, controllable jitter and a long cable simulation.

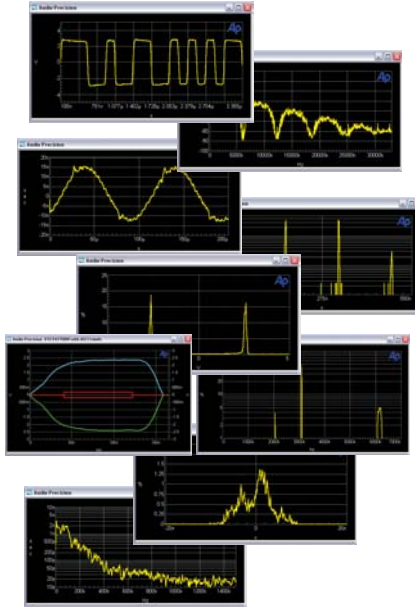

Fully characterize a serial digital bit stream including waveforms, eye patterns, spectrums and histograms, as shown by these nine graphs.



Digital Input/Output panel

Digital Inputs and Outputs

Choose balanced XLR for the AES3 format, unbalanced BNC for the 60958 format, or a Toslink® connector for optical output or input to 192k. The second connectors can be used to switch between cables or in dual-connector mode. Rear-panel jacks provide reference, clock and trigger inputs and outputs.



Rear panel connections

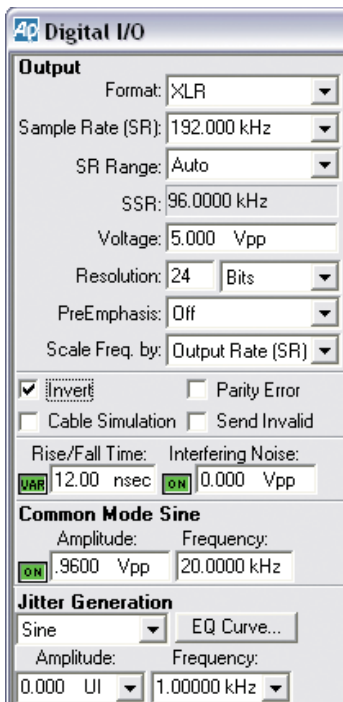

Selectively inject various impairments into the digital signal to test device performance.

Use the Digital Interface Analyzer tool to measure and display the interface signal or jitter waveform and spectrum, histograms for a number of interface measurements or to generate an eye pattern. Add jitter of various types and amplitudes to the generated bitstream and measure the effect on the receiver and the resulting audio signal.

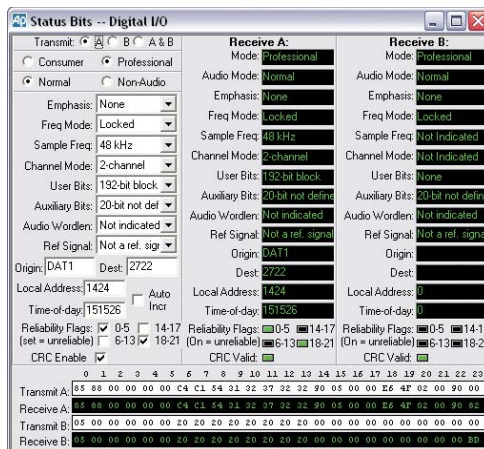

Complete Status Bit metadata setting and display for either consumer or professional format.

- An Eye Pattern is a triggered oscilloscope view of the minimum pulse stream amplitude vs. time, computed over thousands of data cells. The eye opening provides a quick check of signal amplitude, signal-to-noise ratio, rise and fall times and jitter.
- Histograms display the probability distribution of pulse stream parameters like timing (jitter), amplitude, sample rate and bit width. The interface signal and the jitter waveform can be viewed either in the time domain (oscilloscope view) or the frequency domain (FFT spectrum).

Frequency Measurements

Range	<10 Hz to 47% of Sample Rate [10 Hz–23.0 kHz at 48 ks/s].
Accuracy	±0.01% of reading or 0.0001% of Sample Rate, whichever is greater.
Resolution	0.003% of reading or 0.0001% of Sample Rate, whichever is greater.

Quasi-Anechoic Acoustical Tester with "MLS" DSP program

Signals	Four pink sequences, four white sequences.
Frequency Range	(Sample Rate + 2000) to (Sample Rate + 2).
Frequency Resolution (Max)	1.465 Hz at 48.0 ks/s.
Acquisition Length	32767 or 131071 samples.

Multitone Audio Analyzer with "FASTTEST" DSP program

Measurements	Level vs frequency (Response), Total distortion vs frequency, Noise vs frequency, Phase vs frequency, Crosstalk vs frequency, Masking curve.
Frequency Resolution	(Sample Rate + Transform Length) [1.465 Hz with $f_s = 48$ ks/s & Transform Length = 32768].
Distortion	≤-115 dB.

DIGITAL SIGNAL GENERATOR (SYS-2720 and SYS-2722 only)**Interface Signal Characteristics**

Output Formats	Balanced XLR (AES/EBU per AES3-1997), Dual Connector XLR, Unbalanced BNC (SPDIF-EIAJ per IEC-60958), Dual Connector BNC, Optical (Toslink®) per IEC-60958, General purpose parallel, or Serial interface to chip via optional PSIA-2722.
----------------	--

Sample Rate ("SR")

Range	Electrical Formats 28 kHz–200 kHz for fully specified performance; usable from 8 kHz–216 kHz. Optical Format 28 kHz–200 kHz for fully specified performance; usable down to 8 kHz. Upper rate is limited by Toslink® technology.
Resolution	<0.0001 Hz.
Accuracy	±0.0002% [±2 PPM], lockable to external reference.
Output Impedance	Balanced (XLR) Nominally 110 Ω. Unbalanced (BNC) Nominally 75 Ω.
Residual Jitter	≤600 ps (700 Hz–100 kHz analyzer bandwidth), ≤1.0 ns (50 Hz–100 kHz analyzer bandwidth).

Embedded Signal Generation Encoding is selectable 8–24 bit Linear, μ-Law, or A-Law**Sine Family Common Characteristics (all sine wave variants)**

Frequency Range	10 Hz to 47% of Sample Rate [22.56 kHz at 48 ks/s].
Frequency Resolution	Sample Rate + 2 ⁿ [0.006 Hz at 48 ks/s].
Flatness	±0.001 dB.
Harmonics/Spurious Products	≤0.000001% [–160 dB].

Variable Phase Sine Wave

Phase Range	±180 deg.
Sine + Offset	Offset Amplitude Sine amplitude + [offset amplitude] ≤100% F_s .

Sine Burst and Shaped Sine Burst

Interval	2 cycles–65536 cycles.
Burst On	1 to (number of Interval cycles minus 1).

Square Wave

Frequency Range	≤1 Hz to 1/6 Sample Rate. Frequencies are limited to even integer sub-multiples of the Sample Rate.
-----------------	---

SMPT/DIN Waveform

Upper Tone Range	2 kHz to 47% of Sample Rate [22.56 kHz at 48 ks/s].
Lower Tone Range	40 Hz–500 Hz.

CCIF and DFD IMD Waveforms

Center Frequency Range	3.00 kHz to (47% of Sample Rate – 1/2 IM freq.).
IM Frequency Range	80 Hz–2.00 kHz.

DIM IMD Waveform

Square/Sine Frequencies	Determined by Sample Rate
Distortion/Spurious	≤0.000001% [–160 dB].
Amplitude Ratio	4:1 (squarewave:sinewave).

Noise

Types	Pink, White, Burst, USASI.
-------	----------------------------

Special Signals

Monotonicity	Low level staircase waveform for D/A linearity testing.
J-Test	Produces a maximum amount of data-induced jitter on low-bandwidth transmission links.
Polarity	Two sinewaves phased for reinforcement with normal polarity.
Walking Ones	A single binary one value "walked" from LSB to MSB.
Walking Zeros	A single binary zero value "walked" from LSB to MSB.
Constant Value (Digital dc)	32-bit resolution when using triangular dither.
Random (Bittest)	Pseudo-random binary states of all bits.
Pass Thru	Passes the signal from the rear panel Ref Input. Accepts sample rates from 27 kHz–200 kHz and outputs at programmed sample rate. Ratio of rates may not exceed 7.75:1.

Quasi-Anechoic Acoustical Tester (MLS)

Signals	Four pink sequences, four white sequences.
Frequency Range	dc to Sample Rate + 2.
Sequence Length	32767 samples or 131071 samples.

Arbitrary and Multitone Waveforms ("Arb Wfm")

Signal	Determined by the associated file specified in the panel drop-down box.
Frequency Range	dc to Sample Rate + 2.
Length	256 points–16384 points per channel. Utility is provided to prepare waveform from user specified frequency, amplitude, and phase data.
Frequency Resolution	Sample Rate + Length [2.93 Hz at 48 ks/s for a waveform 16384 points in length].

Maximum Number of Tones (Length / 2) – 1 [8191 for Length = 16384].**Dither**

Probability Distribution	Triangular or rectangular; pseudo random, independent for each channel.
Spectral Distribution	Flat (white) or Shaped (+6 dB/oct).
Amplitude	8 bit–24 bit, or OFF.

Pre-Emphasis Filters

Filter Shape	50/15 μs or J17.
Response Accuracy	±0.02 dB, 10 Hz to 45% of Sample Rate.
Residual Distortion	≤0.00003% [–130 dB].

DIGITAL ANALYZER (SYS-2720 and SYS-2722 only)**Digital Interface Signal Measurements**

Input Sample Rate	Range 28 kHz–200 kHz for fully specified performance; typically <24 kHz–216 kHz.
Accuracy	Int. Reference ±(0.0003% + 1 digit) [±3 PPM]. Ext. Reference ±(0.0001% + 1 digit) [±1 PPM].
Input Amplitude	Balanced (XLR) 0 Vpp–10.00 Vpp, ±(5% + 25 mV). Unbalanced (BNC) 0 Vpp–2.5 Vpp, ±(5% + 6 mV). Optical Displays output voltage of Toslink® receiver (not linearly related to optical input power).

Output to Input Delay	Measures propagation from the rear panel AES/EBU Reference Output to the input. Range –12.7 to +115.1 UI [–10% to +90% of frame] in seconds, 60 ns resolution.
-----------------------	---

Residual Jitter	≤600 ps *700 Hz–100 kHz* bandwidth, ≤1.0 ns *50 Hz–100 kHz* bandwidth.
-----------------	--

Digital Interface Analyzer with "INTERVU" DSP program

AES/EBU Input Voltage	Balanced 0 Vpp–10.00 Vpp, ±(10% + 50 mV). Unbalanced 0 Vpp–2.5 Vpp, ±(8% + 12 mV).
Acquisition time / memory	. 19.66 ms / 1,572,864 samples.

Embedded Audio Measurements with "ANALYZER" DSP program

Wideband Level/Amplitude	Range –120 dBFS _s to 0 dBFS _s (usable to –140 dBFS _s). Frequency Range 10 Hz to 45.8% of Sample Rate, [10 Hz–20.2 kHz at 44.1 ks/s], [10 Hz–22.0 kHz at 48 ks/s], [10 Hz–44.0 kHz at 96 ks/s]. Accuracy ±0.01 dB. Flatness ±0.01 dB, 15 Hz–22 kHz (<10 Hz high-pass filter selection).
--------------------------	---

High pass Filters	<10 Hz (4-pole), 22 Hz (4-pole), 100 Hz (4-pole), 400 Hz (4-pole Butterworth, or 10-pole elliptic if no other filters are enabled).
Low pass Filters	$F_s/2$ (maximum bandwidth), 20 kHz (6-pole elliptic), 15 kHz (6-pole elliptic).
Weighting Filters	ANSI-IEC "A" weighting, per IEC Rec 179, CCIR QPk per CCIR Rec. 468, CCIR RMS per AES17, C-message per IEEE Std 743-1978, CCITT per CCITT Rec. O.41, "F" weighting corresponding to 15 phon loudness contour, HI-2 Harmonic weighting.

Residual Noise (at 48 ks/s and 96 ks/s f_s)	–141 dBFS unweighted, –144 dBFS A-weighted, –140 dBFS CCIR RMS, –130 dBFS CCIR QPk, –142 dBFS 20 kHz LP, –143 dBFS 15 kHz LP, –139 dBFS "F" weighting, –152 dBFS CCITT, –151 dBFS C Message.
--	---

Narrow Band Amplitude

Frequency Range	10 Hz to 40% of Sample Rate, [10 Hz–17.6 kHz at 44.1 ks/s], [10 Hz–19.2 kHz at 48 ks/s], [10 Hz–38.4 kHz at 96 ks/s]
-----------------	--

THD+N Measurements

Frequency Range	<10 Hz to 47% of Sample Rate, [10 Hz–19.9 kHz at 44.1 ks/s], [10 Hz–21.6 kHz at 48 ks/s], [10 Hz–43.2 kHz at 96 ks/s].
Residual THD+N	≤–138 dBFS.
High pass Filters	<10 Hz (4-pole), 22 Hz (4-pole), 100 Hz (4-pole), 400 Hz (4-pole Butterworth).
Low pass Filters	$F_s/2$ (maximum bandwidth), 20 kHz (6-pole elliptic), 15 kHz (6-pole elliptic).
Weighting Filters	Same as Wideband Level/Amplitude.

Frequency Measurements

Range	10 Hz to 47% of Sample Rate, [10 Hz–21.0 kHz at 44.1 ks/s], [10 Hz–23.0 kHz at 48 ks/s], [10 Hz–46.0 kHz at 96 ks/s].
-------	---

Embedded Audio, FFT Spectrum Analyzer with "FFT" DSP program (48 bit processing)

Acquisition Length	800 samples–4 M samples in 15 steps.
Transform Length	256–32768 samples in binary steps.
Windows	Ten choices
Averaging	1–4096 averages in binary steps. Averaging is power-based (frequency domain), or synchronous (time domain).
Distortion Products	≤–160 dB.

Embedded Audio, Multitone Audio Analyzer with "FASTTEST" DSP program (48 bit processing)

Acquisition Length	512–32768 samples in binary steps.
Transform Length	512–32768 samples in binary steps.
Measurements	Level vs frequency, Total distortion vs frequency, Noise vs frequency, Phase vs frequency, Crosstalk vs frequency, Masking curve.
Frequency Resolution	Sample Rate + 2 ⁿ [1.465 Hz with 48 ks/s].
Frequency Correction Range	±3%.
Distortion	≤–140 dB.

Embedded Audio, Quasi-Anechoic Acoustical Tester with "MLS" DSP program

Signals	Four pink sequences and four white sequences, selected by triggering generator MLS setting.
---------	---

FRONT PANEL AUXILIARY SIGNALS

Generator Monitors (all units except SYS-2720)	Channel A; Channel B
Generator Auxiliary Signals (all units except SYS-2720)	Sync Output/ Trig/Gate Input
Analyzer Signal Monitors (all units except SYS-2720)	Channel A; Channel B; Reading
Digital Signal Monitors (SYS-2720 and SYS-2722 only)	Channel 1; Channel 2; Reading 1; Reading 2

REAR PANEL AUXILIARY SIGNALS**Reference Input ("REF IN") Characteristics**

Input formats	28 kHz–200 kHz AES/EBU, NTSC, PAL, or SECAM video, or 8 kHz–10 MHz square wave.
---------------	---

Reference Output ("REF OUT") Characteristics

Output format	AES/EBU (per AES3-1997).
---------------	--------------------------

GENERAL/ ENVIRONMENTAL

Power Requirements	100/120/230/240 Vac (–10%/+6%), 50/60 Hz, 240 VA max.
EMC	Complies with 89/336/EEC, CISPR 22 (class B), and FCC 15 subpart J (class B).
Dimensions	Width 41.9 cm [16.5 inches]. Height 14.6 cm [5.75 inches] bench-top (feet attached) 3U [5.25 inches] rack-mount. Depth 34.5 cm [13.6 inches].
Weight	Approximately 15.4 kg [34 lbs].
Safety	Complies with 73/23/EEC, 93/68/EEC, and EN61010-1 (1990) + Amendment 1 (1992) + Amendment 2 (1995). Installation Category II, Pollution Degree 2.

Block Diagram
SYS-2722



SYS-2722



SYS-2720



SYS-2712



SYS-2702

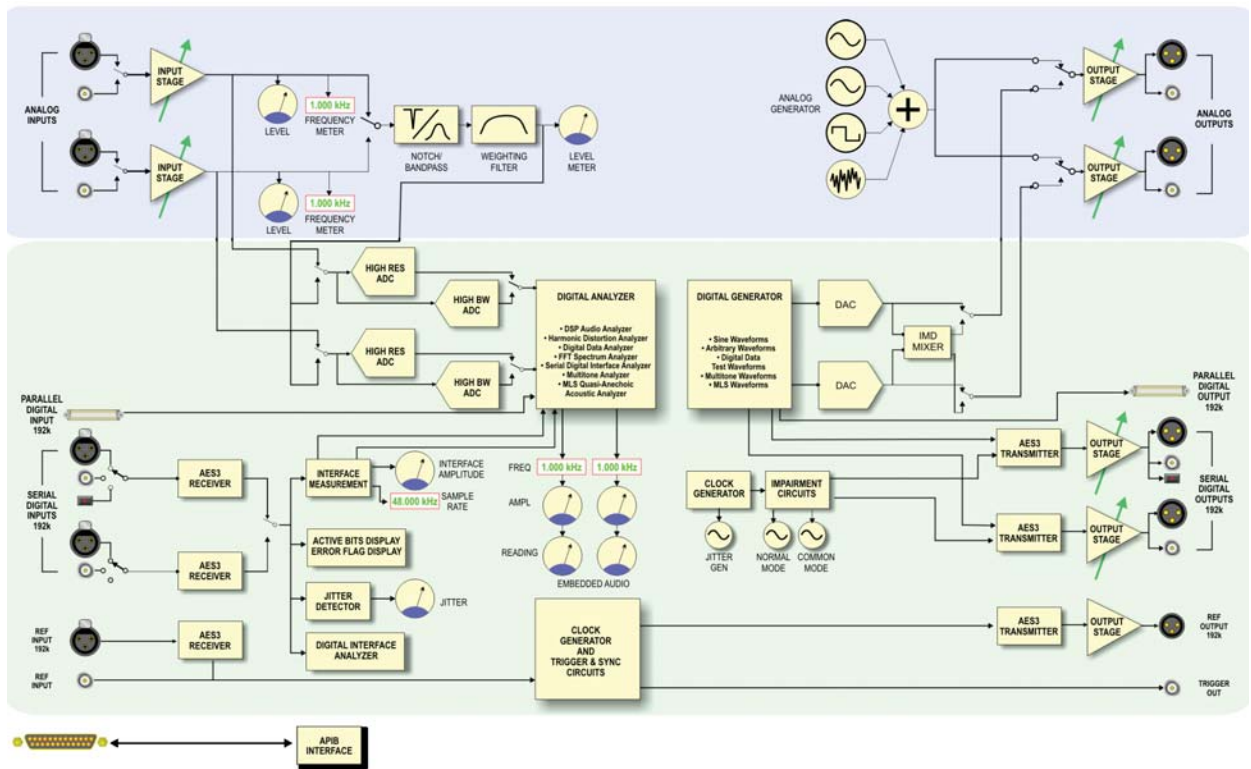

The 2700 series is available in four models to test analog signals, digital signals or both (dual domain).

SYS-2722 offers analog and digital inputs and outputs, DSP analysis of both digital and internally-converted analog signals, DSP-generated digital and analog signals, and low-distortion, hardware-implemented generation and analysis for analog signals. It is a true dual domain instrument.

SYS-2720 offers digital input and output and DSP generation and analysis of digital signals. It has no analog I/O capabilities.

SYS-2712 offers analog inputs and outputs, DSP analysis of internally-converted analog signals, DSP-generated analog signals, and low-distortion hardware-implemented signal generation and analysis. It has no digital I/O capabilities.

SYS-2702 offers analog input and output, with low-distortion hardware-implemented signal generation and analysis. It has no digital I/O capabilities.

The **GPIB** option adds an IEEE-488 interface to the instrument.

Three major internal analog options may be fitted to all instruments except the digital-only SYS-2720. Note that some BUR- and IMD-type capabilities are already provided in DSP generation and analysis for SYS-2722 and SYS-2712.

The **BUR** option adds analog-domain generation of burst sine waves with controllable burst duration, interval and amplitude between bursts. It also includes analog-generated square waves to 20 kHz, analog random and pseudorandom white and pink noise, and bandpass-filtered pink noise.

The **IMD** option tests analog-domain devices for intermodulation distortion to the SMPTE/DIN, CCIF and DIM/TIM standards.

The **W&F** option measures analog wow & flutter to the IEC/DIN, NAB, JIS, and scrape flutter standards, weighted or unweighted.

A 2700 series **APIB** interface connects the instrument to your PC, and is included with all models, except the GPIB option. APIB is available in your choice of an ISA, PCI or PCMCIA PC card.

Each instrument except the digital-only SYS-2720 can accept up to seven analog filter option modules, selectable from a large assortment of lowpass, bandpass and psophometric weighting filters. Other external accessories include the **PSIA-2722** Programmable Serial Interface Adapter for connecting to devices that use non-standard serial interfaces, the **SWR-2122** family of high-performance signal switchers/multiplexers and the **DCX-127** DC/Ohms/low speed digital logic multi-function module.

2700 SERIES ORDERING INFORMATION

Models	
SYS-2722	Analog and Digital Input and Output, with DSP. Dual domain, 192k.
SYS-2720	Digital Input and Output, with DSP. 192k.
SYS-2712	Analog Input and Output, with DSP
SYS-2702	Analog Input and Output

Options	
BUR	Analog burst sine waves, square waves to 20 kHz, random and pseudorandom white and pink noise signals
IMD	Analog Intermodulation Distortion to SMPTE/DIN, CCF and DIM/TIM standards
W&F	Wow & Flutter to IEC/DIN, NAB, JIS and scrape flutter standards, weighted or unweighted
EWP-2700	Three-Year Extended Warranty (Adds three more years to standard three-year warranty included with instrument)

Interface Options (selected at time of order)	
S2-ISA	ISA Interface Card w/AP2700 software
S2-PCI	PCI Interface Card w/AP2700 software
S2-PCMCIA	PCMCIA Interface Card w/AP2700 software
-G	IEEE-488 (GPIB) Interface

Filters	
S-AES17	Lowpass filter for AES17 DAC measurements
OPT-2020	Lowpass filter for DAC measurements
FIL-xxx	Family of analog psophometric noise weighting filters
FLP-xxx	Family of analog sharp lowpass filters
FBP-xxx	Family of analog 1/3 octave bandpass filters

External Accessories	
AUX-0025	Switching Amplifier Measurement Filter
PSIA-2722	Programmable Serial Interface Adapter
SWR-2122	12x2 switcher family expandable to 192 channels
DCX-127	Multifunction module including 4 1/2 digit DC voltmeter/ohmmeter with miscellaneous digital control ports.
RAK-S2	Rackmount kit
HAN-S2	Carrying handle



Testing for Optimal Results

5750 SW Arctic Drive
Beaverton, OR 97005
Tel: 503-627-0832
FAX : 503-641-8906
US Toll Free: 1-800-231-7350

audioprecision.com